

TV-MODUL

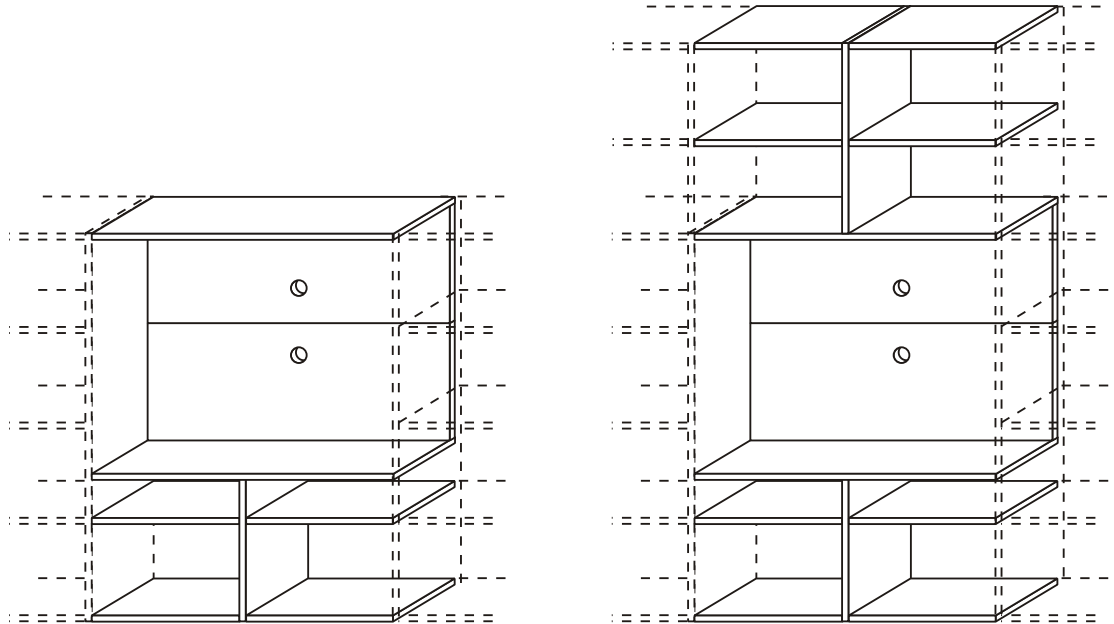

- | | |
|---|-------------------------------------|
| (D) Montageanleitung | (GB) Assembly instructions |
| (FR) Notice de montage | (IT) Istruzioni di montaggio |
| (NL) Handleiding voor de montage | (PL) Instrukcja montażu |
| (CZ) Montážní návod | (SK) Návod na montáž |
| (HU) Szerelési útmutató | (RO) Instrucțiuni de montaj |
| (TR) Montaj talimati | (RU) Инструкция по монтажу |

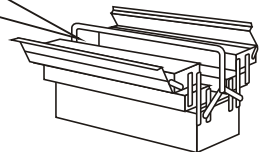

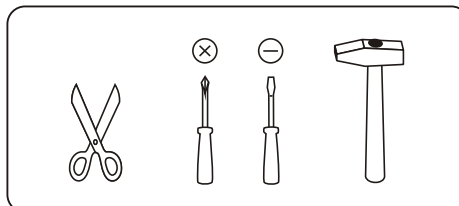
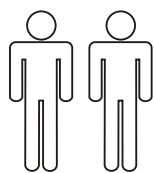
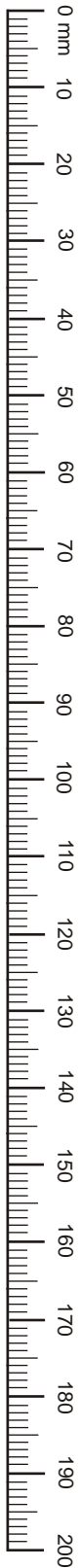

Service • Asststenza • Dienstverlening • Serwis Servis • Szerviz • Сервисная служба		
Name • Nom • Nome • Naam Nazwa • Jméno • Názov • Név Denumire • Isim • Название		
Nr. • No. • N° • Номер • Č • Sz		
Тур • Type • Tip • Típus • Tipo Тип		

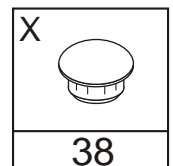
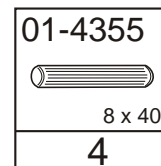
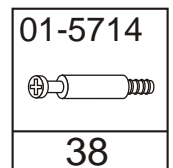
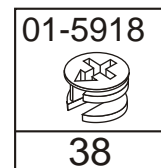
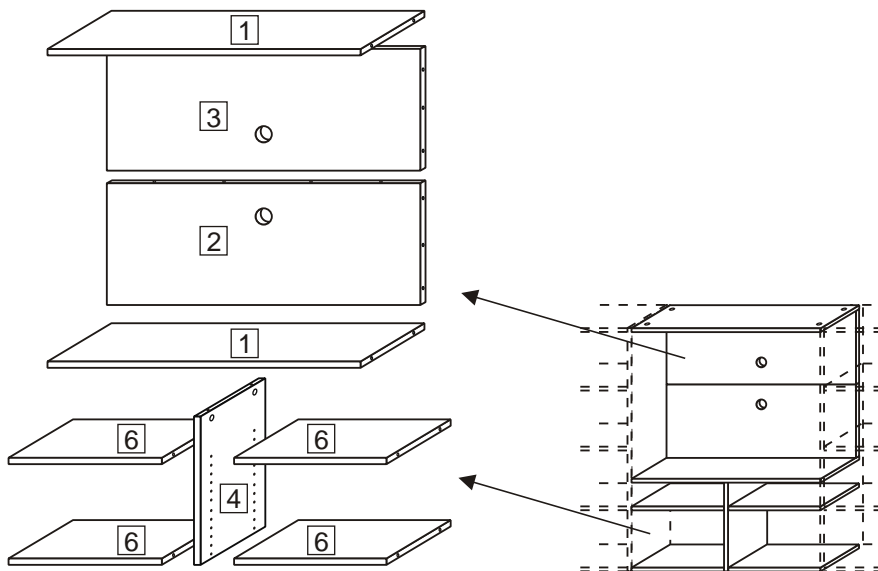
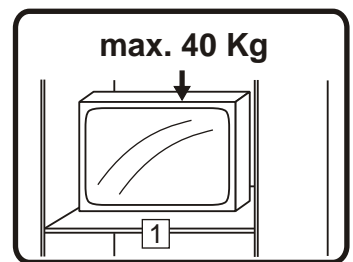
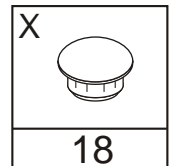
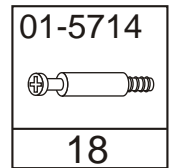
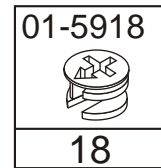
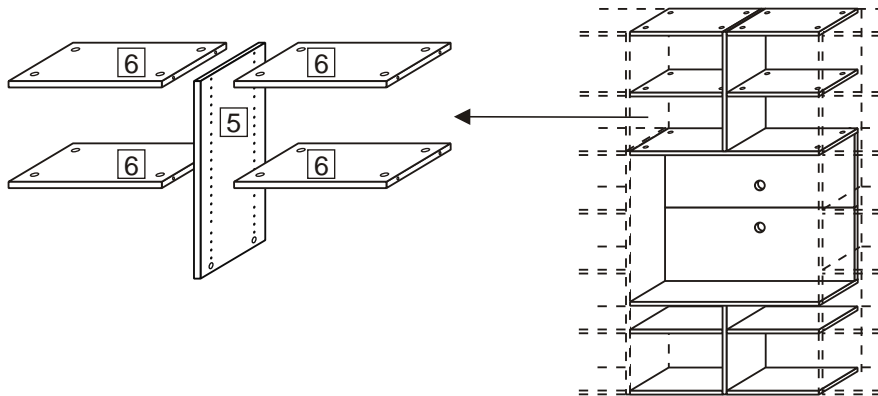

D	Bitte nur mit einem Staubtuch oder leicht feuchtem Lappen reinigen. Keine scheuernden Putzmittel verwenden.	CZ	Čistěte prosím jen prachovkou nebo lehce navlhčeným hadrem. Nepoužívejte drhnuocí čisticí prostředky.
GB	Please only clean with a duster or a damp cloth. Do not use any abrasive cleaners.	SK	Na čistenie používajte len prachovku alebo zľahka navlhčenú utierku. Nepoužívajte žiadne drhnuce čistiace prostriedky.
F	Veillez nettoyer uniquement avec un chiffon à poussière ou un chiffon légèrement humide. Ne pas utiliser de détergent abrasif.	HU	Kérjük, csak portörő kendővel vagy enyhén nedves ronggyal tisztítsa. Ne használjon dörzsható tisztítószeret.
IT	Si raccomanda di pulire solo con un panno per la polvere o uno strofinaccio umido. Non utilizzare detergenti abrasivi.	RO	Vă rugăm să utilizați la curățare exclusiv o cârpă de șters prafuri sau o cârpă ușor umezită. Nu utilizați substanțe de curățat abrazive.
NL	Reinig alleen met een stofdoek of een lichtjes vochtige doek. Gebruik geen schurende poetsmiddelen.	TR	Lütfen sadece bir toz bezikle veya hafif nemli yumuşak bir bezle siliniz. Aşındırıcı temizlik malzemeleri kullanmayınız.
PL	Czyszczenie należy wykonać wyłącznie za pomocą ściereczki lub lekko nawilżonego ręcznika. Nie stosować środków czyszczących do szorowania.	RU	Очищайте от пыли тряпкой или слегка влажной ветошью. Не допускается применение чистящих средств, не предназначенных для ухода за мебелью.

1

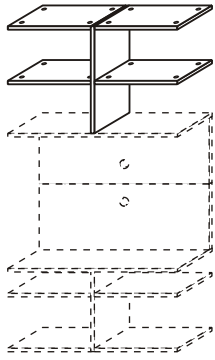

01-5918 18	01-5714 18
-------------------	-------------------

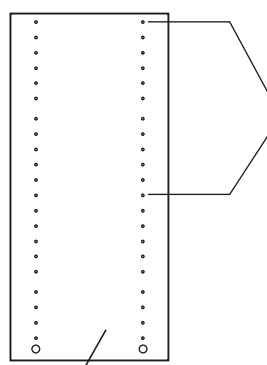

01-5714

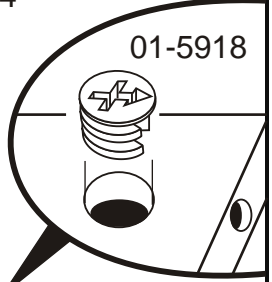

01-5918

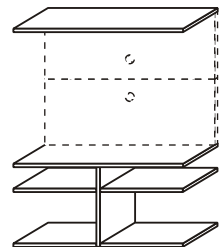
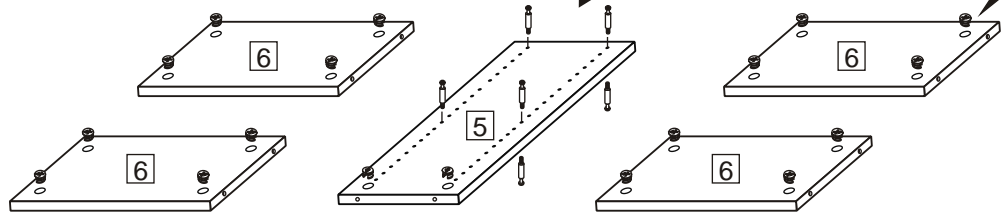

01-5918 26	01-5714 10
-------------------	-------------------

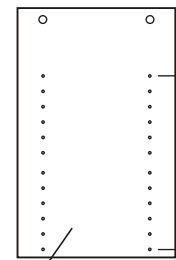

01-5714

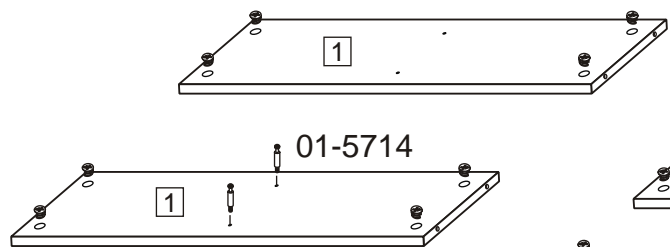

01-5714

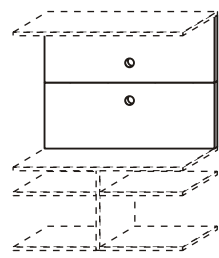
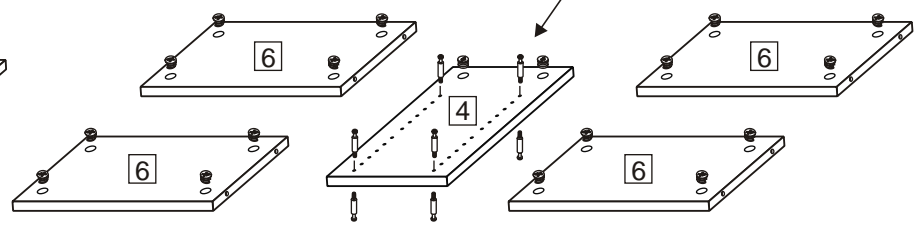

01-4355 8 x 40 4	01-5918 12
----------------------------	-------------------

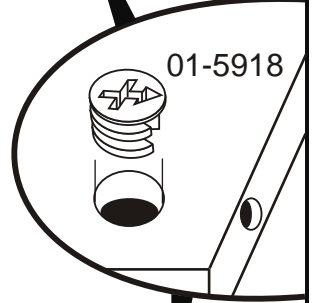
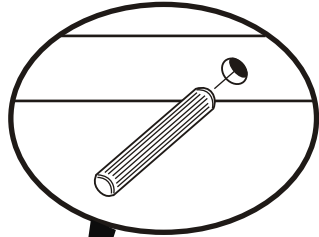

01-5918

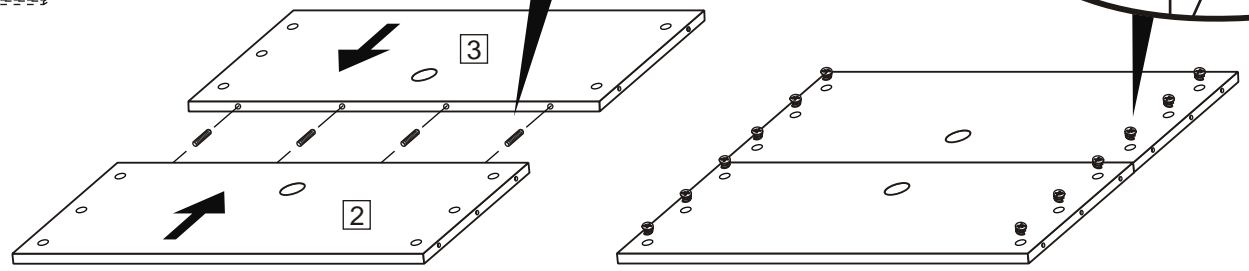

2

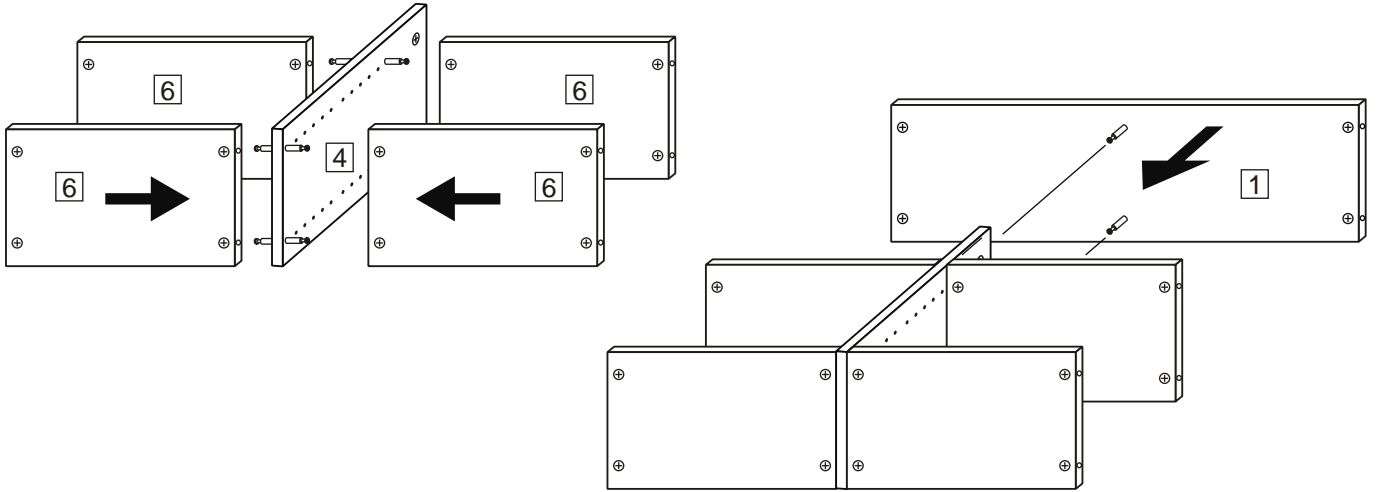
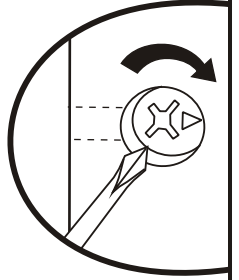
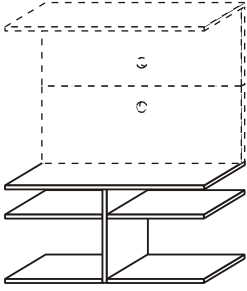

3

